

**MQ12 MALE 0° / MQ12 FEMALE 0°**

PVC 4X0.34 black 2m

Male straight – female straight

MQ12 – MQ12, 4-pole

Further cable lengths on request.

Plastic housings with good resistance against chemicals and oils.

The resistance to aggressive media should be individually tested for your application. Further details on request.

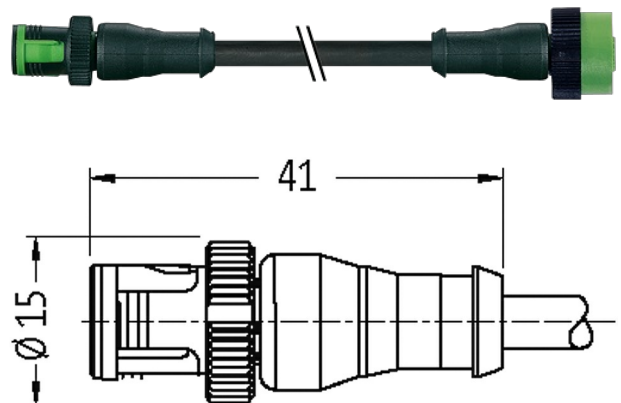
[Link to Product](#)**Illustration**

Product may differ from Image

**Form**

Form 40021

**General data**

Temperature range -25...+85 °C, depending on cable quality

**Cables**

No./diameter of wires	4 × 0.34 mm <sup>2</sup>
Wire isolation	PVC (br, wh, bl, bk)
Material (jacket)	PVC (UL/CSA)
Outer Ø	5.0 mm ±5%
Bend radius (moving)	10 × outer Ø
Temperature range (fixed)	-30...+80 °C
Temperature range (mobile)	-5...+80 °C
Cable identification	614
Cable Type	1 (PVC)
Approval (cable)	UL (AWM-Style 2464/1731), CSA
Cable weight [g/m]	40,70
Material (wire)	Cu wire, bare
Resistor (core)	max. 60 Ω/km (20 °C)
Single wire Ø (core)	0.15 mm
Construction (core)	19 × 0.15 mm (multi-strand wire class 5)
Diameter (core)	4 × 0.34 mm <sup>2</sup>
AWG	similar to AWG 22
Material (wire isolation)	PVC
Material property (wire isolation)	CFC-, cadmium-, silicone- and lead-free

Shore hardness (wire isolation)	45 ±5 D
Wire-Ø incl. isolation	1.25 mm ±5%
Color/numbering of wires	br, bk, bl, wh
Stranding combination	4 wires twisted
Shield	no
Material (jacket)	PVC
Material property (jacket)	CFC-, cadmium-, silicone- and lead-free
Shore hardness (jacket)	85 ±5 A
Outer-Ø (jacket)	5.0 mm ±5%
Color (jacket)	black
chemical resistance	good resistance to oil, gasoline and chemicals
thermal resistance	flame retardant UL 1581 VW1 / CSA FT1
Nominal voltage	UL 300 V AC
Test voltage	2000 V AC
Current load capacity	to DIN VDE 0298-4
Temperature range (fixed)	-30...+80 °C
Temperature range (mobile)	-5...+80 °C
Bend radius (fixed)	5× outer Ø
Bend radius (moving)	10× outer Ø
Jacket Color	black

#### Technical Data

Operating voltage	max. 250 V AC/DC
Rated surge voltage	2.5 kV
Operating current per contact	max. 4 A
Locking of ports	Quick connection, 1/4 turn
Protection	IP65 and IP67 when plugged and screwed down (EN 60529)

#### Commercial data

country of origin	DE
customs tariff number	85444290
EAN	4048879106344
eClass	27279218
Packaging unit	1

#### Sketch



Male

Female

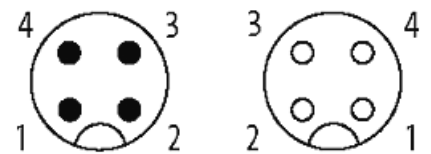

Product may differ from Image